

MANISCOPIC

MRT 2150 PRIVILEGE



- Lift height : 20.60 m
- Max. reach : 18.10 m
- Engine : 150 HP - 110 kw
- 4 wheel drive - 4 wheel steer
- Hydrostatic transmission
- Levelling system

 **MANITOU**

ROTATION ON STABILISERS FULLY EXTENDED WITH EXTENSIBLE PLATFORM 2,25/4 m

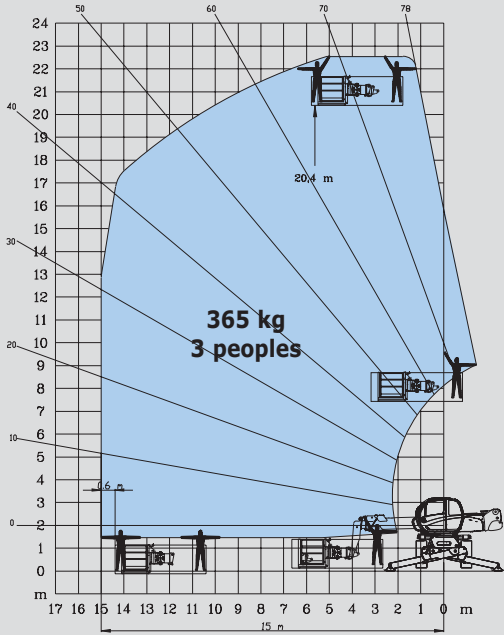

ROTATION ON STABILISERS FULLY EXTENDED WITH 1000 KG PLATFORM 2,25/4 m

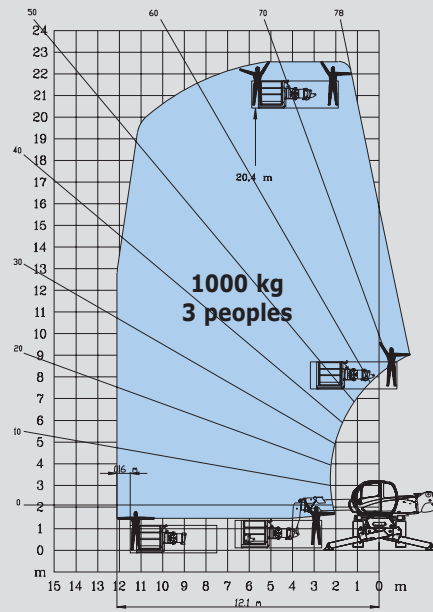

ROTATION ON STABILISERS FULLY EXTENDED WITH 3 D SYSTEM IN POSITIVE POSITION

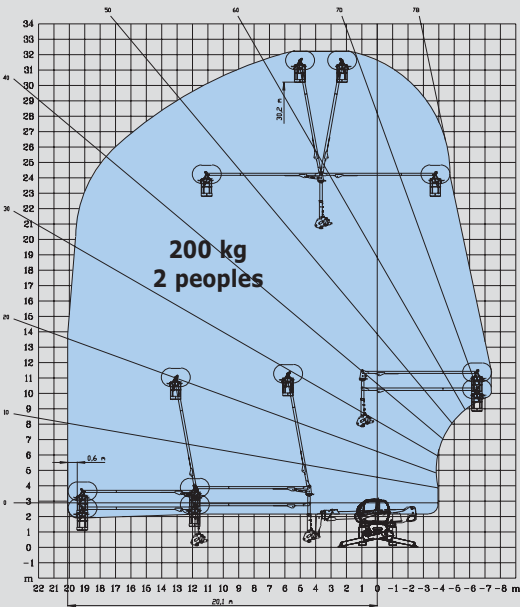

ROTATION ON STABILISERS FULLY EXTENDED WITH 3 D SYSTEM IN NEGATIVE POSITION

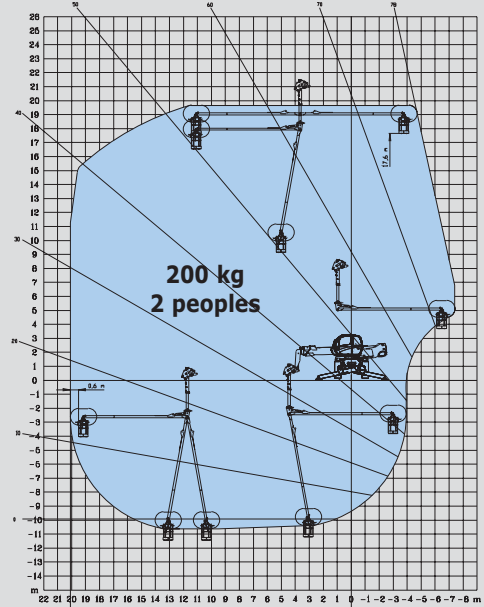







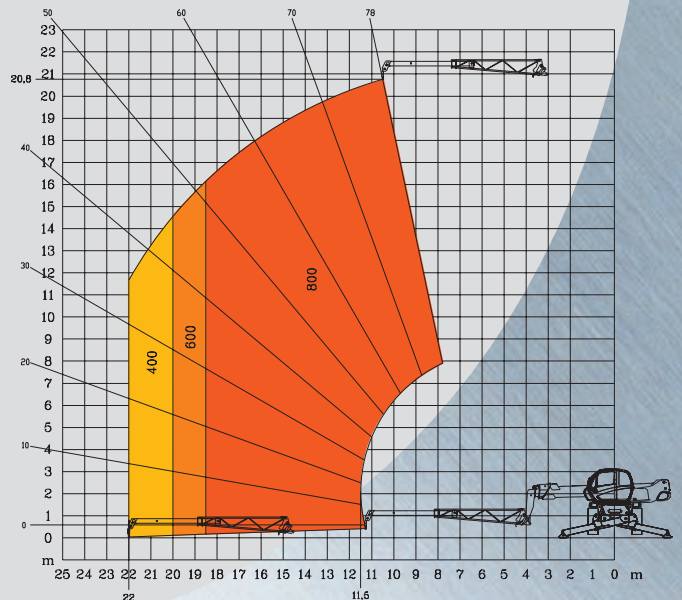







ROTATION ON STABILISERS FULLY EXTENDED WITH AERIAL JIB PLATFORM



ROTATION ON STABILISERS FULLY EXTENDED WITH CRANE JIB



MRT 2150 *PRIVILEGE*

-  **Lift capacity** (on stabilisers)4999 kg
at 500 mm from forks heels
-  **Lift height** :20.60 m
-  **Tyres**
18 - 22,5
-  **Forks** (mm)
Length1200
Width x thickness150 X 50
-  **Multidisc brakes** : hydraulically assisted on both axles
Negative parking brake
-  **Engine Mercedes-Benz**
TypeOM 904 LA (EURO 3
Capacity4 cyl. 4250 cm³
Power (ISO/TR 14396)150 HP/110 kw
580 Nm of 1200 at 1600 rpm
Water cooling
Direct injection
-  **Transmission**hydrostatic
With automatic power regulation (hydraulic variable
displacement pump and motor)
Reversing shiftelectromagnetic
2 speed forward and reverse
Travel speed36 km/h*
*This speed may be limited by local regulations
-  **Rear axle**
Frame levelling on front axle +/- 8° (15%)
Automatic rear axle locking system
over 15° rotation
-  **4 stabilizers**
simultaneous or individually controlled
-  **Total and continuous rotation**
Turret mounted on a double slew ring
Hydraulic and electric rotation
-  **Hydraulics**
3 pumps gear type270 bars/160 l/mn
-  **Control** : 2 electro proportional control joysticks for all
hydraulic movements
-  **Capacities**
Cooling system18 l.
Engine oil15 l.
Hydraulic oil200 l.
Fuel tank230 l.
-  **Weight unladen** (with forks)16095 kg
Overall width2.43 m
Overall height3.05 m
Overall length6.78 m
Ground clearance0.37 m
Drawbar pull8200 daN
-  **Standard load moment indicator**
(mobile crane standards)

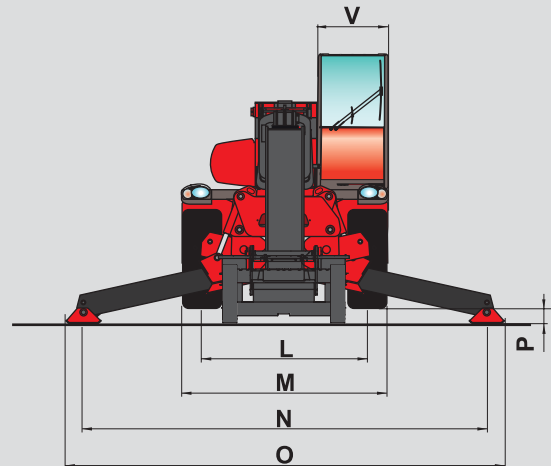
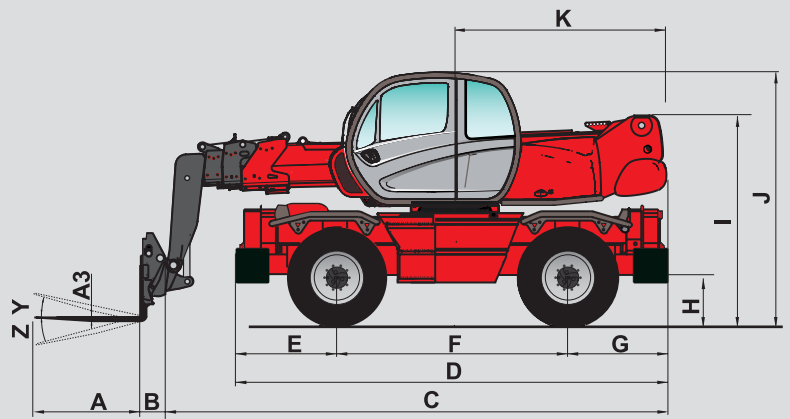

A	1200
A1	150
A2	1320
A3	50
B	290
C	6490
D	5050
E	1155
F	2750
G	1155
H	380
I	2485
J	3050
K	2485
L	1930
M	2425
N	4700
O	5100
P	150
Q	4500
R	3800
S	4550
T	4040
U	6230
V	950
Y	12°
Z	105°

mm

This publication in no way constitutes an offer and the company reserves the right to alter specification without prior notice.
The MANITOU models presented in this brochure can be supplied complete with optional equipment attachments.



MANITOU BF SA

B.P. 249 - 44158 Ancenis Cedex - France
Tél. : 33 2 40 09 10 11 / Export Department Fax : 33 2 40 09 10 97
www.manitou.com

700384EN-A - 04/07

